



Planning Commission Staff Report

Meeting Date: July 3, 2018

Agenda Item: 8A

ABANDONMENT CASE NUMBER: WAB18-0003 (Sievert)

BRIEF SUMMARY OF REQUEST: Abandon all the government patent easements on two parcels

STAFF PLANNER: Planner's Name: Eva Krause, AICP
Phone Number: 775.328.3628
E-mail: ekrause@washoecounty.us

CASE DESCRIPTION

For hearing, discussion, and possible action to approve the abandonment of the 33-foot wide easements that run along all four sides of both Government Home-sites on lots 85 and 86 of document number 347118. Any approval only applies to the interest Washoe County owns in the easement.

Owner/Applicant: Kristian and Regina Sievert

Location: 2600 feet southeast of the intersection of Thomas Creek Road and Arrowcreek Pkwy.

APN: 142-242-11

Parcel Size: 5 acres

Master Plan: Suburban and Rural

Regulatory Zone: Low Density Suburban and General Rural

Area Plan: Southwest Truckee Meadows

Citizen Advisory Board: South Truckee Meadows/Washoe Valley

Development Code: Authorized in Article 806, Vacations and Abandonments of Streets and Easements

Commission District: 2 – Commissioner Lucey

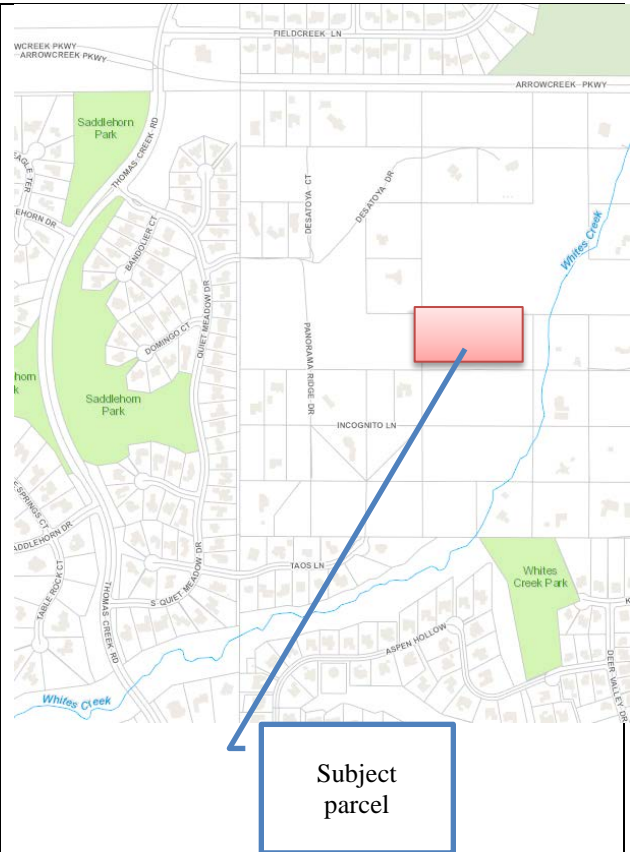

STAFF RECOMMENDATION

APPROVE

APPROVE WITH CONDITIONS

DENY

POSSIBLE MOTION

I move that, the Washoe County Planning Commission approve with conditions Abandonment Case Number WAB18-0003 for Kristian and Regina Sievert.

(Motion with Findings on Page 7)

Staff Report Contents

Abandonment Definition..... 3
Vicinity Map 4
Site Plan 4
Project Evaluation 5
Statute, Code and Policy Regarding Patent Easements..... 5
Reviewing Agencies..... 6
Recommendation..... 7
Motion 7
Appeal Process..... 7

Exhibits Contents

Conditions of Approval.....Exhibit A
Engineering and Capital Projects letterExhibit B
Public Notice Map Exhibit C
Project Application Exhibit D

Abandonment Definition

The purpose of an abandonment is to allow for the vacation or abandonment of easements or streets. If the Planning Commission grants an approval of the Abandonment, that approval is subject to Conditions of Approval. Conditions of Approval are requirements that need to be completed prior to the recordation of the Resolution and Order of Abandonment.

The Resolution and Order of Abandonment is the legal record, prepared by the Engineering and Capital Projects Division which is recorded to complete the abandonment process. The Engineering and Capital Projects Division completes a technical review of the legal description, exhibit maps and any new easements, submitted by the applicants surveyor, that are required by the Conditions of Approval. When the Engineering and Capital Projects Division is satisfied that all conditions of approval have been met, then the Engineering and Capital Projects Division will record the Resolution and Order of Abandonment with the County Recorder. The abandonment is complete upon the recordation of the Resolution and Order of Abandonment with the County Recorder.

The Conditions of Approval for Abandonment Case Number WAB18-0003 is attached to this staff report and will be included with the Action Order if granted approval.

- All conditions of approval are required to be completed before the abandonment can be recorded and finalized.
- The abandonment will be effective after the approval of a Resolution and Order of Abandonment by the Engineering and Capital Projects Division and after the recordation of the Resolution and Order of Abandonment by the County Recorder.

The subject property consists of two lots that have been consolidated. The property has a regulatory zone of Low Density Suburban and General Rural. The applicant states they wish to build a residence on the property. Residential use is permitted in both regulatory zones. The abandonment of the easements will increase the options for locating a residence on the property. The approval of the abandonment is not an approval of a use on the property.



Vicinity Map

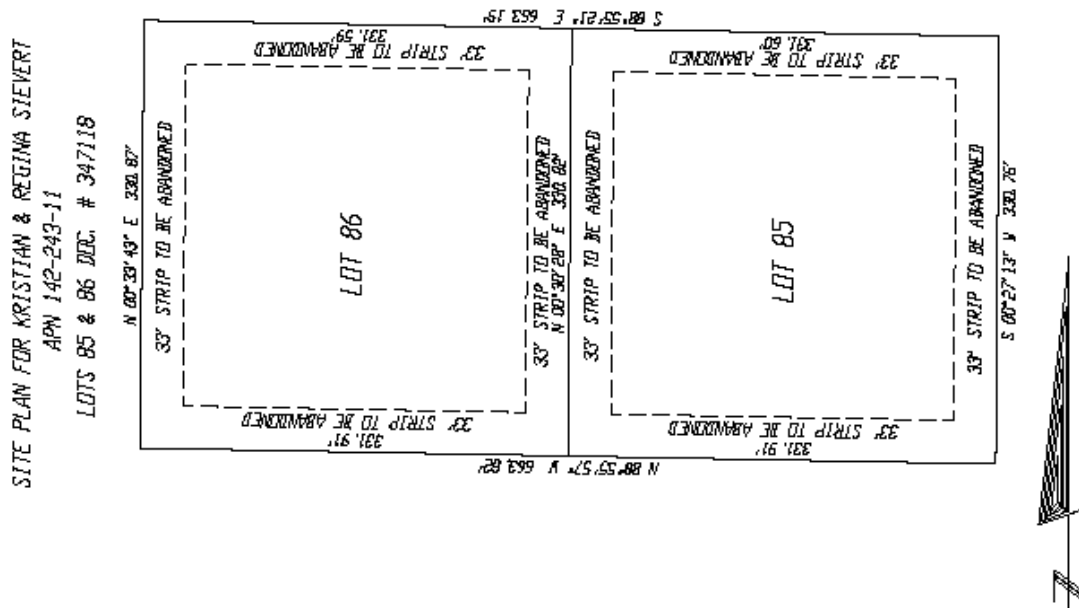

Site Plan

Project Evaluation

The subject property consists of two lots (lots 85 and 86) that have been merged into one parcel. When the lots were created each lot had a 33-foot wide patent easement running along all four sides of the property lines. The merging of the lots did not remove the recorded easement. Because access easements more than 20-feet wide are considered property fronts, the 30-foot front yard setback is measured from the edge of the easement. Because the two 33-foot easements still bisect the 5 acre parcel, and a 30-foot setback is required from the all access easements, approximately 3 acres of the 5 acre parcel cannot be built on.

The properties abutting the north, west and south sides of the subject parcel are owned by United States of America, and are not available for development. The property to the east of the subject property is developed with a single family residence.

White's Creek is located approximately 85-feet east of the subject property. A small portion of Lot 85 is within the Whites Creeks sensitive stream zone, and this area has a regulatory zone of GR (\pm 0.1 acre). If the abandonment is approved, the east side would have a 50 foot side yard. Most of the sensitive stream zone would be located within the side yard setback. Crossing Whites Creek to access the subject property is potentially detrimental to the critical stream zone, therefore staff recommends that the easement on the east side of the property be abandon to discourage any development of access from that direction.

Statute, Code and Policy Regarding Patent Easements

Washoe County Code (WCC) Section 110.806.70, states, in part, "The abandonment or vacation of a government patent easement ... addresses only the County's interest in the subject easement and cannot be relied upon for purposes of clearing title to the property." To the extent other property owners nearby or other entities might have any ownership interests in these easements, the County's action to abandon or not abandon would not affect those interests. In turn, the property owners applying for the abandonment would be responsible for utilizing whatever legal mechanisms are necessary to address those interests on their own.

NRS 278.480 allows for the Planning Commission to consider abandoning government patent easements if they are no longer required for a public purpose. In general, a government patent access easements are presumed to serve a public purpose when they either: (1) function as a point of access; or (2) are adjacent to undeveloped land that does not have developed means of ingress/egress.

There are two principal questions for the County to consider in a patent easement abandonment application: first, whether the easement is no longer required for a public purpose; and, second, whether the proposed abandonment would cause a material injury to the public.

The properties surrounding the subject parcel have developed access, or are publicly owned properties that are not available for development, therefore the access easements subject to this abandonment are no longer required.

Notice to Utilities and Video Service Providers

NRS 278.480(6) requires that notice be given to utility and video service providers in the area to determine if they wish an easement to be reserved for their benefit. Comments from entities to which this applies are noted below under the Reviewing Agencies section. Any entities that desire the reservation of an easement must notify the county in writing once they are made aware of the pending abandonment/vacation request.

Reviewing Agencies

The following agencies received a copy of the project application for review and evaluation.

- Washoe County Community Services Department
 - Planning and Building Division
 - Engineering and Capital Projects Division
 - Regional Parks and Open Spaces
 - Water Management Planner
- Truckee Meadows Fire Protection District
- Regional Transportation Commission
- Washoe-Storey Conservation District
- NV Energy
- AT&T
- Truckee Meadows Water Authority

Two out of the ten above listed agencies/departments provided comments and/or recommended conditions of approval in response to their evaluation of the project application. A **summary** of each agency's comments and/or recommended conditions of approval and their contact information is provided. The Conditions of Approval document is attached to this staff report and will be included with the Action Order if the Planning Commission approves the requested abandonment.

Washoe County Planning and Building Division provided conditions regarding recordation of the Resolution and Order of Abandonment.

Contact: Eva M. Krause, 775.328.3628, ekrause@washoecounty.us

Washoe County Engineering and Capital Projects Division provided conditions related to recordation of the abandonment, retention or relocation of utility easements.

Contact: Leo Vesely, 775.328.2313, Lvesely@washoecounty.us

Staff Comment on Required Findings

WCC Section 110.806.20 requires that all of the following findings be made to the satisfaction of the Washoe County Planning Commission before granting approval of the abandonment request. Staff has completed an analysis of the application and has determined that the proposal is in compliance with the required findings as follows.

1. Master Plan. The abandonment or vacation is consistent with the policies, action programs, standards and maps of the Master Plan and the Area Plan.

Staff Comments: Abandonment of the easements does not affect any policies, action programs, standards of map of either the Master Plan or the Southwest Truckee Meadows Area Plan.

2. No Detriment. The abandonment or vacation does not result in a material injury to the public.

Staff Comments: The surrounding properties either have developed access or they are public lands and are not available for development.

3. Existing Easements. Existing public utility easements in the area to be abandoned or vacated can be reasonably relocated to provide similar or enhanced service.

Staff Comments: As a condition of approval, utility easements shall be retained or relocated to the satisfaction of, and at no expense to, Washoe County or any existing public utility.

4. No longer required for a public purpose (NRS 278.480(3)). The government patent easement is no longer required for a public purpose.

Staff Comments: The easements are unimproved and are not necessary for access to any of the surrounding parcels. Therefore, the easements are no longer required for a public purpose.

Recommendation

Those agencies which reviewed the application recommended conditions in support of approval of the project or provided no comment. Therefore, after a thorough analysis and review, Abandonment Case Number WAB18-0003 is being recommended for approval with conditions. Staff offers the following motion for the Commission's consideration.

Motion

I move that, after giving reasoned consideration to the information contained in the staff report and information received during the public hearing, the Washoe County Planning Commission approve Abandonment Case Number WAB18-0003 for Kristian and Regina Sievert, with the conditions included in Exhibit A to this matter, having made all three findings in accordance with Washoe County Code Section 110.806.20, and a fourth finding in accordance with Nevada Revised Statutes 278.480(3):

1. Master Plan. The abandonment or vacation is consistent with the policies, action programs, standards and maps of the Master Plan and the Southwest Truckee Meadows Area Plan; and
2. No Detriment. The abandonment or vacation does not result in a material injury to the public; and
3. Existing Easements. Existing public utility easements in the area to be abandoned or vacated can be reasonably relocated to provide similar or enhanced service.
4. No longer required for a public purpose (NRS 278.480(3)). The government patent easement is no longer required for a public purpose.

Appeal Process

Planning Commission action will be effective 10 calendar days after the written decision is filed with the Secretary to the Planning Commission and mailed to the applicant(s), unless the action is appealed to the Washoe County Board of County Commissioners, in which case the outcome of the appeal shall be determined by the Washoe County Board of County Commissioners. Any appeal must be filed in writing with the Planning and Building Division within 10 calendar days from the date the written decision is filed with the Secretary to the Planning Commission and mailed to the applicant(s).

Applicant/Owner: Kristian and Regina Sievert, 3910 Nature Trail, Reno, NV, 89511

Representatives: Dennis Chapman, Landmark Surveying, hubtacpls@gmail.com



Conditions of Approval

Abandonment Case Number WAB18-0003

The project approved under Abandonment Case Number WAB18-0003 shall be carried out in accordance with the Conditions of Approval granted by the Planning Commission on July 3, 2018. Conditions of Approval are requirements placed on a permit or development by each reviewing agency. These Conditions of Approval may require submittal of documents, applications, fees, inspections, amendments to plans, and more. These conditions do not relieve the applicant of the obligation to obtain any other approvals and licenses from relevant authorities required under any other act or to abide by all other generally applicable Codes, and neither these conditions nor the approval by the County of this project/use override or negate any other applicable restrictions on uses or development on the property. Furthermore, to the extent that Washoe County does not own the easements in question, it cannot abandon them. Therefore, this request is in effect a “quitclaim” by the County of whatever interest it might have in the easements in favor of the owners who applied for the abandonment. Nothing in this abandonment should be construed as an assertion by the County of ownership over the easements in question. To the extent other property owners nearby or other entities might have any ownership interests in these easements, this abandonment does not affect those interests and the property owners associated with this abandonment are responsible for utilizing whatever legal mechanisms are necessary to address those interests on their own.

Unless otherwise specified, all conditions related to the approval of this Abandonment shall be met prior to recordation of the Resolution and Order of Abandonment. Prior to recordation of the Resolution and Order of Abandonment, each agency shall determine when compliance of their specific conditions is met by the applicant as set forth in the Conditions of Approval. All agreements, easements, or other documentation required by these conditions shall have a copy filed with the County Engineer and the Community Services Department – Planning and Building Division.

Compliance with the conditions of approval related to this Abandonment is the responsibility of the applicant, his/her successor in interest, and all owners, assignees, and occupants of the property and their successors in interest. All conditions of approval must be met prior to the Engineering and Capital Projects Division recording the required Resolution and Order of Abandonment.

For the purpose of conditions imposed by Washoe County, “may” is permissive and “shall” or “must” is mandatory.

- All conditions of approval are required to be completed before the Abandonment can be recorded and finalized.
- The abandonment will be effective after the approval of a Resolution and Order of Abandonment by the Engineering and Capital Projects and after the recordation of the Resolution and Order of Abandonment by the County Recorder.

FOLLOWING ARE CONDITIONS OF APPROVAL REQUIRED BY THE REVIEWING AGENCIES. EACH CONDITION MUST BE MET TO THE SATISFACTION OF THE ISSUING AGENCY.

Washoe County Planning and Building Division

1. The following conditions are requirements of the Planning and Building Division, which shall be responsible for determining compliance with these conditions.

Contact Name – Eva M. Krause, AICP, Planner, 775.328.3628, ekrause@washoecounty.us

- a. The applicant shall demonstrate substantial conformance to the plans approved as part of this abandonment action.
- b. This Abandonment will be effective upon recordation of the Resolution and Order of Abandonment by the County Recorder.

Washoe County Engineering and Capital Projects Division

2. The following conditions are requirements of Engineering and Capital Projects Division, which shall be responsible for determining compliance with these conditions.

Contact Name – Leo Vesely, P.E., 775.328.2313, lvesely@washoecounty.us

- a. Prior to recordation of the Resolution and Order of Abandonment, the applicant shall submit legal descriptions and exhibit maps for the area of abandonment and any new easements that may be required, to the Engineering and Capital Projects Division for review and approval. The legal descriptions and exhibit maps shall be prepared by a Nevada professional land surveyor.
- b. Retention or relocation of all public utility easements is required to the satisfaction of and at no expense to Washoe County or the existing public utilities that originally accepted and approved said easements, as well as any other public utilities now in existence that currently utilize said easements. Said relocations shall be evidenced by the recordation of properly executed documents reflecting the grant of new easements (if required) to said public utilities and the relinquishment by said public utilities of their former easements.
- c. Prior to recordation of the Resolution and Order of Abandonment, the applicant shall grant a drainage easement for the perpetuation of the FEMA flood hazard area along the eastern side of the parcel.
- d. The applicant shall comply with conditions necessary to effect the Resolution and Order of Abandonment within two (2) years from the date of the action by the Planning Commission or this conditional abandonment will be null and void.

*** End of Conditions ***



WASHOE COUNTY
COMMUNITY SERVICES DEPARTMENT
Engineering and Capital Projects

1001 EAST 9TH STREET
 PO BOX 11130
 RENO, NEVADA 89520-0027
 PHONE (775) 328-3600
 FAX (775) 328.3699

INTEROFFICE MEMORANDUM

DATE: June 05, 2018
TO: Eva Krause, Planning and Development Division
FROM: Leo R. Vesely, P.E., Engineering and Capitol Projects Division
SUBJECT: **WAB18-0003**
APN 142-242-11
SIEVERT ABANDONMENT CONDITIONS

Washoe County Engineering and Capital Projects Division staff has reviewed the referenced abandonment and recommends approval subject to the following conditions of approval. The Washoe County Engineer shall determine compliance with the following conditions of approval.

1. Prior to recordation of the Order of Abandonment, the applicant shall submit legal descriptions and exhibit maps for the area of abandonment and any new easements that may be required, to the Engineering and Capital Projects Division for review and approval. The legal descriptions and exhibit maps shall be prepared by a Nevada professional land surveyor.
2. Retention or relocation of all public utility easements is required to the satisfaction of and at no expense to Washoe County or the existing public utilities that originally accepted and approved said easements, as well as any other public utilities now in existence that currently utilize said easements. Said relocations shall be evidenced by the recordation of properly executed documents reflecting the grant of new easements (if required) to said public utilities and the relinquishment by said public utilities of their former easements.
3. Prior to recordation of the Order of Abandonment, the applicant shall grant a drainage easement for the perpetuation of the FEMA flood hazard area along the eastern side of the parcel.
4. The applicant shall comply with conditions necessary to effect the Resolution and Order of Abandonment within two (2) years from the date of the action by the Planning Commission or this conditional abandonment will be null and void.

LRV/Irv



INTEGRITY



EFFECTIVE COMMUNICATION



QUALITY PUBLIC SERVICE

WAB18-0003
EXHIBIT B

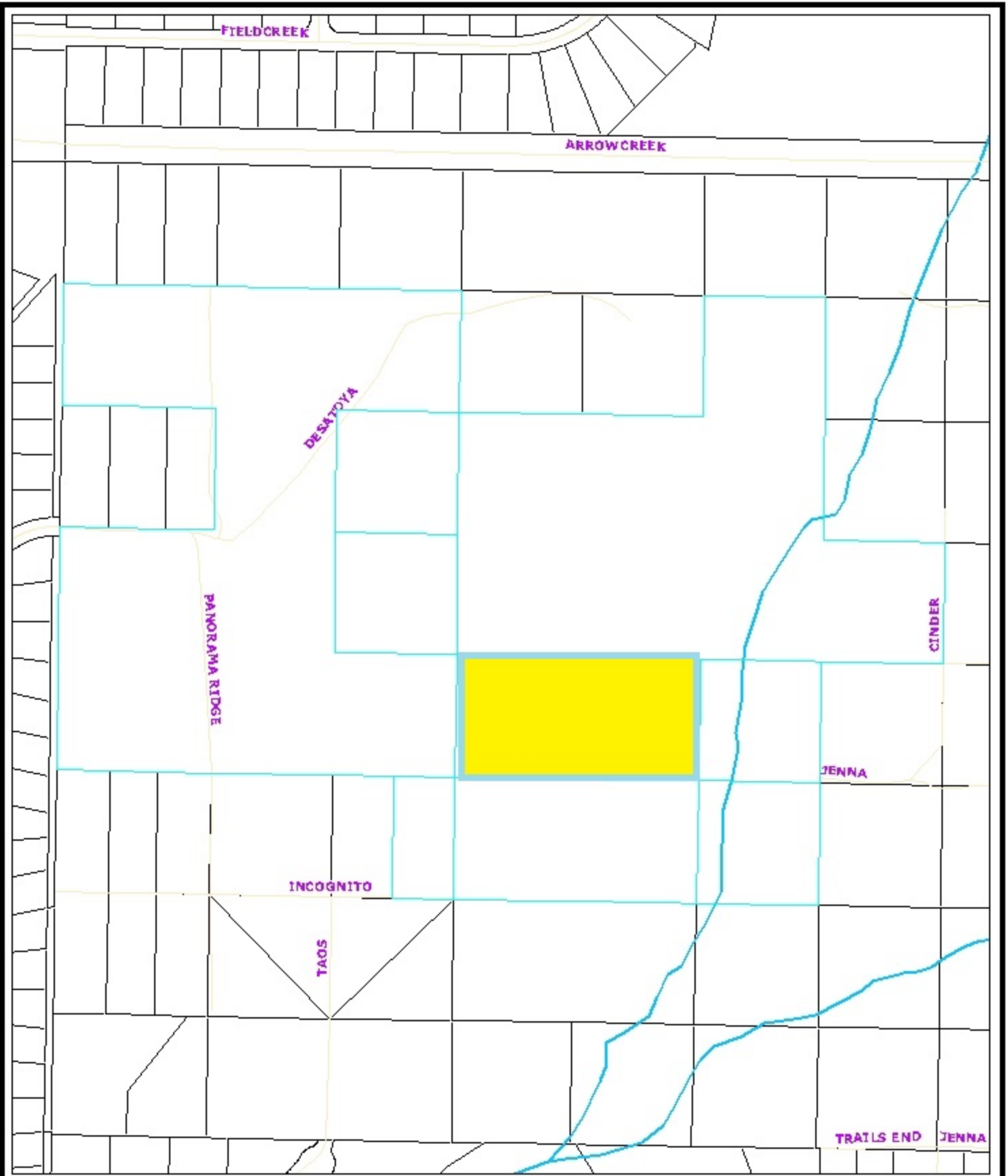

WAB18-0003 Public Notice Map

Property owners abutting or connected to proposed abandonment



- Noticed Parcels
- Subject Parcel

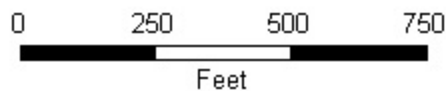

Community Services
Department, Planning
and Building Division



Real Office Box 11120
Reno, Nevada 89520 (775) 223-2800

Source: Planning and Building

Date: May 2018

ORIGINAL

Washoe County Development Application

Your entire application is a public record. If you have a concern about releasing personal information, please contact Planning and Development staff at 775.328.3600.

Project Information		Staff Assigned Case No.: _____	
Project Name: SIEVERT ABANDONMENT			
Project Description: GOVERNMENT LOTS 85 AND 86			
Project Address:			
Project Area (acres or square feet): 5.04 ACRES			
Project Location (with point of reference to major cross streets AND area locator): 2600 FEET SOUTHEAST OF THE INTERSECTION OF THOMAS CREEK RD & ARROWCREEK PKW			
Assessor's Parcel No.(s):	Parcel Acreage:	Assessor's Parcel No(s):	Parcel Acreage:
142-242-11	5.04 AC.		
Section(s)/Township/Range: 30, T. 18N., R. 20E MDM			
Indicate any previous Washoe County approvals associated with this application: Case No.(s).			
Applicant Information (attach additional sheets if necessary)			
Property Owner:		Professional Consultant:	
Name: KRISTIAN & REGINA SIEVERT		Name: LANDMARK SURVEYING	
Address: 3910 NATURE TRAIL		Address: 2548 RAMPART TERRACE	
RENO, NV.	Zip: 89511	RENO, NV.	Zip: 89519
Phone:	Fax:	Phone: 775-324-0904	Fax: 775-324-0904
Email:		Email: hubtacpls@gmail.com	
Cell:	Other:	Cell: 775-772-6058	Other:
Contact Person:		Contact Person: DENNIS CHAPMAN	
Applicant/Developer:		Other Persons to be Contacted:	
Name: SAME AS OWNER		Name:	
Address:		Address:	
	Zip:		Zip:
Phone:	Fax:	Phone:	Fax:
Email:		Email:	
Cell:	Other:	Cell:	Other:
Contact Person:		Contact Person:	
For Office Use Only			
Date Received:	Initial:	Planning Area:	
County Commission District:		Master Plan Designation(s):	
CAB(s):		Regulatory Zoning(s):	

Property Owner Affidavit

Applicant Name: KRISTIAN SIEVERT

The receipt of this application at the time of submittal does not guarantee the application complies with all requirements of the Washoe County Development Code, the Washoe County Master Plan or the applicable area plan, the applicable regulatory zoning, or that the application is deemed complete and will be processed.

STATE OF NEVADA)

COUNTY OF WASHOE)

I, KRISTIAN SIEVERT

(please print name)

being duly sworn, depose and say that I am the owner* of the property or properties involved in this application as listed below and that the foregoing statements and answers herein contained and the information herewith submitted are in all respects complete, true and correct to the best of my knowledge and belief. I understand that no assurance or guarantee can be given by members of Planning and Development.

(A separate Affidavit must be provided by each property owner named in the title report.)

Assessor Parcel Number(s): 142-242-11

Printed Name KRISTIAN SIEVERT

Signed *Kristian Sievert*

Address 3910 NATURE TRAIL, RENO NV. 89511

Subscribed and sworn to before me this

24th day of April, 2018
by Kristian Sievert.

Jackie Moritzky
Notary Public in and for said county and state

My commission expires: 9-10-19

(Notary Stamp)

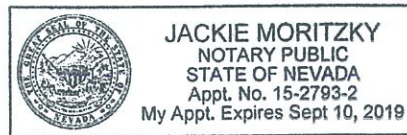

*Owner refers to the following: (Please mark appropriate box.)

- Owner
- Corporate Officer/Partner (Provide copy of recorded document indicating authority to sign.)
- Power of Attorney (Provide copy of Power of Attorney.)
- Owner Agent (Provide notarized letter from property owner giving legal authority to agent.)
- Property Agent (Provide copy of record document indicating authority to sign.)
- Letter from Government Agency with Stewardship

February 2014

WAB18-0003
EXHIBIT D

Property Owner Affidavit

Applicant Name: REGINA SIEVERT

The receipt of this application at the time of submittal does not guarantee the application complies with all requirements of the Washoe County Development Code, the Washoe County Master Plan or the applicable area plan, the applicable regulatory zoning, or that the application is deemed complete and will be processed.

STATE OF NEVADA)

COUNTY OF WASHOE)

I, REGINA SIEVERT
(please print name)

being duly sworn, depose and say that I am the owner* of the property or properties involved in this application as listed below and that the foregoing statements and answers herein contained and the information herewith submitted are in all respects complete, true and correct to the best of my knowledge and belief. I understand that no assurance or guarantee can be given by members of Planning and Development.

(A separate Affidavit must be provided by each property owner named in the title report.)

Assessor Parcel Number(s): 142-242-11

Printed Name REGINA SIEVERT

Signed 

Address 3910 NATURE TRAIL, RENO, NV. 89511

Subscribed and sworn to before me this
24th day of April, 2018.

by Regina Sievert.

Notary Public in and for said county and state

My commission expires: 9-10-19

(Notary Stamp)

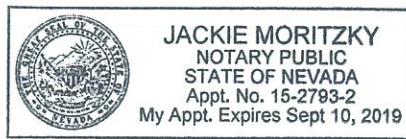

*Owner refers to the following: (Please mark appropriate box.)

- Owner
- Corporate Officer/Partner (Provide copy of recorded document indicating authority to sign.)
- Power of Attorney (Provide copy of Power of Attorney.)
- Owner Agent (Provide notarized letter from property owner giving legal authority to agent.)
- Property Agent (Provide copy of record document indicating authority to sign.)
- Letter from Government Agency with Stewardship

Abandonment Application Supplemental Information

(All required information may be separately attached)

Chapter 110 of the Washoe County Code is commonly known as the Development Code. Specific references to vacations and abandonments may be found in Article 806, Vacations and Abandonments of Easements or Streets.

1. What is the abandonment being requested?

THE 66.00 FOOT STRIP CENTERED ON LOTS 85 AND 86, AND THE 33 FOOT STRIP AROUND THE BOUNDARY OF LOTS 85 AND 86, DOCUMENT NUMBER 347118.

2. On which map or document (please include with application) is the easement or right-of-way first referenced?

DOCUMENT NUMBER 347118
PATENT NUMBER 1221865

3. What is the proposed use for the vacated area?

APPLICANT WANTS TO BUILD A HOME ON THE LOCATION OF THE EASEMENT.

4. What replacement easements are proposed for any to be abandoned?

NONE

5. What factors exist or will be employed to prevent the proposed abandonment from resulting in significant damage or discrimination to other property in the vicinity?

NONE

6. Are there any restrictive covenants, recorded conditions, or deed restrictions (CC&Rs) that apply to the area subject to the abandonment request? (If so, please attach a copy.)

Yes

No

Washoe County Treasurer
Tammi Davis

Washoe County Treasurer
P.O. Box 30039, Reno, NV 89520-3039
ph: (775) 328-2510 fax: (775) 328-2500
Email: tax@washoecounty.us

Bill Detail

[Back to Account Detail](#)

[Change of Address](#)

[Print this Page](#)

Washoe County Parcel Information		
Parcel ID	Status	Last Update
14224211	Active	4/27/2018 2:06:26 AM
Current Owner: SIEVERT, KRISTIAN & REGINA 3910 NATURE TRL RENO, NV 89511		SITUS: 0 MOUNT ROSE HWY WCTY NV
Taxing District 4000	Geo CD:	
Legal Description		
Township 18 Section 30 Lot 85 86 Block Range 20 SubdivisionName _GOVERNMENT HOMESITES		

Installments						
Period	Due Date	Tax Year	Tax	Penalty/Fee	Interest	Total Due
INST 1	8/21/2017	2017	\$0.00	\$0.00	\$0.00	\$0.00
INST 2	10/2/2017	2017	\$0.00	\$0.00	\$0.00	\$0.00
INST 3	1/1/2018	2017	\$0.00	\$0.00	\$0.00	\$0.00
INST 4	3/5/2018	2017	\$0.00	\$0.00	\$0.00	\$0.00
Total Due:			\$0.00	\$0.00	\$0.00	\$0.00

Tax Detail			
	Gross Tax	Credit	Net Tax
State of Nevada	\$98.92	(\$43.33)	\$55.59
Truckee Meadows Fire Dist	\$314.22	(\$137.62)	\$176.60
Washoe County	\$809.81	(\$354.69)	\$455.12
Washoe County Sc	\$662.47	(\$290.15)	\$372.32
TRUCKEE MDWS/SUN VALLEY WATER BASIN	\$0.03	\$0.00	\$0.03
Total Tax	\$1,885.45	(\$825.79)	\$1,059.66

Payment History				
Tax Year	Bill Number	Receipt Number	Amount Paid	Last Paid
2017	2017072300	B17.136261	\$264.91	10/19/2017
2017	2017072300	B17.136262	\$264.91	10/19/2017
2017	2017072300	B17.139964	\$10.60	10/30/2017
2017	2017072300	B17.176293	\$264.90	12/29/2017
2017	2017072300	B17.36072	\$264.94	8/9/2017

Pay By Check

Please make checks payable to:
WASHOE COUNTY TREASURER

Mailing Address:
P.O. Box 30039
Reno, NV 89520-3039

Overnight Address:
1001 E. Ninth St., Ste D140
Reno, NV 89512-2845

Change of Address

All requests for a mailing address change must be submitted in writing, including a signature (unless using the online form).

To submit your address change online [click here](#)

Address change requests may also be faxed to: (775) 328-2500

Address change requests may also be mailed to:
Washoe County Treasurer
P O Box 30039
Reno, NV 89520-3039

The Washoe County Treasurer's Office makes every effort to produce and publish the most current and accurate information possible. No warranties, expressed or implied, are provided for the data herein, its use, or its interpretation. If you have any questions, please contact us at (775) 328-2510 or tax@washoecounty.us

This site is best viewed using Google Chrome, Internet Explorer 11, Mozilla Firefox or Safari.

Nevada 024625

The United States of America,

To all whom these presents shall come, Greeting:

WHEREAS, a Certificate of the Land Office at Reno, Nevada, has been issued showing that full payment has been made by the claimant Frederick W. Schwamb, pursuant to the provisions of the Act of Congress approved June 1, 1938 (52 Stat. 609), entitled "An Act to provide for the purchase of public lands for home and other sites," and the acts supplemental thereto, for the following-described land:

Mount Diablo Meridian, Nevada.

T. 18 N., R. 20 E.,

Sec. 30, Lots 85 and 86.

The area described contains 5.00 acres, according to the Official Plat of the Survey of the said Land, on file in the Bureau of Land Management:

NOW KNOW YE, That the UNITED STATES OF AMERICA, in consideration of the premises, and in conformity with the several Acts of Congress in such case made and provided, HAS GIVEN AND GRANTED, and by these presents DOES GIVE AND GRANT unto the said claimant and to the heirs of the said claimant the Tract above described; TO HAVE AND TO HOLD the same, together with all the rights, privileges, immunities, and appurtenances, of whatsoever nature, thereunto belonging, unto the said claimant and to the heirs and assigns of the said claimant forever; subject to any vested and accrued water rights for mining, agricultural, manufacturing, or other purposes, and rights to ditches and reservoirs used in connection with such water rights, as may be recognized and acknowledged by the local customs, laws, and decisions of courts; and there is reserved from the lands hereby granted, a right-of-way thereon for ditches or canals constructed by the authority of the United States. Excepting and reserving, also, to the United States all oil, gas and other mineral deposits, in the land so patented, together with the right to prospect for, mine, and remove the same according to the provisions of said Act of June 1, 1938. This patent is subject to a right-of-way not exceeding 33 feet in width, for roadway and public utilities purposes, to be located along the boundaries of said land.

IN TESTIMONY WHEREOF, the undersigned authorized officer of the Bureau of Land Management, in accordance with the provisions of the Act of June 17, 1948 (62 Stat., 476), has, in the name of the United States, caused these letters to be made Patent, and the Seal of the Bureau to be hereunto affixed.

GIVEN under my hand, in the District of Columbia, the TENTH day of AUGUST in the year of our Lord one thousand nine hundred and SIXTY-ONE and of the Independence of the United States the one hundred and EIGHTY-SIXTH.

For the Director, Bureau of Land Management.

By Ruth W. Talley
Chief, Patents Section.



Patent Number 1221865

SITE PLAN FOR KRISTIAN & REGINA SIEVERT
APN 142-243-11
LOTS 85 & 86 DOC. # 347118

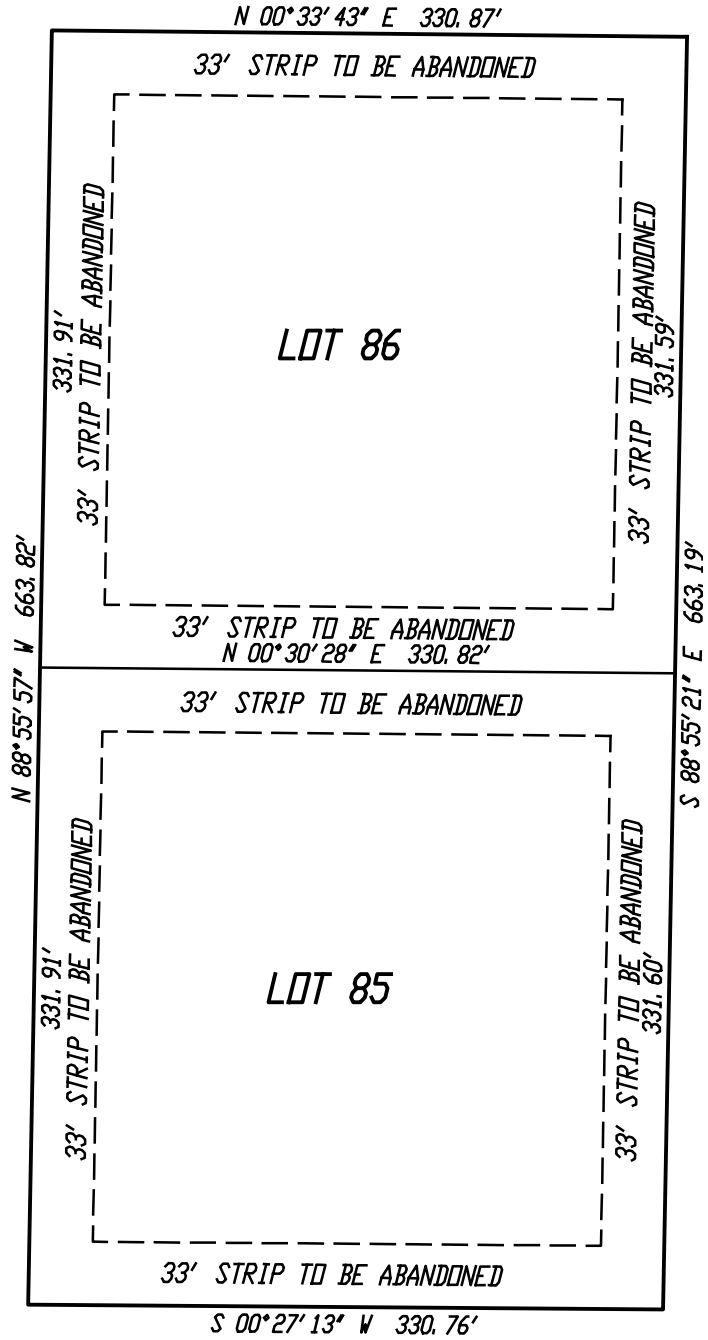

SCALE 1"=100'

PETER DUBE
142-250-09

USA
142-242-06

USA
142-250-04

STOLER
142-260-17

USA
142-242-12

FENID
142-242-16

TALBOTT
142-242-10

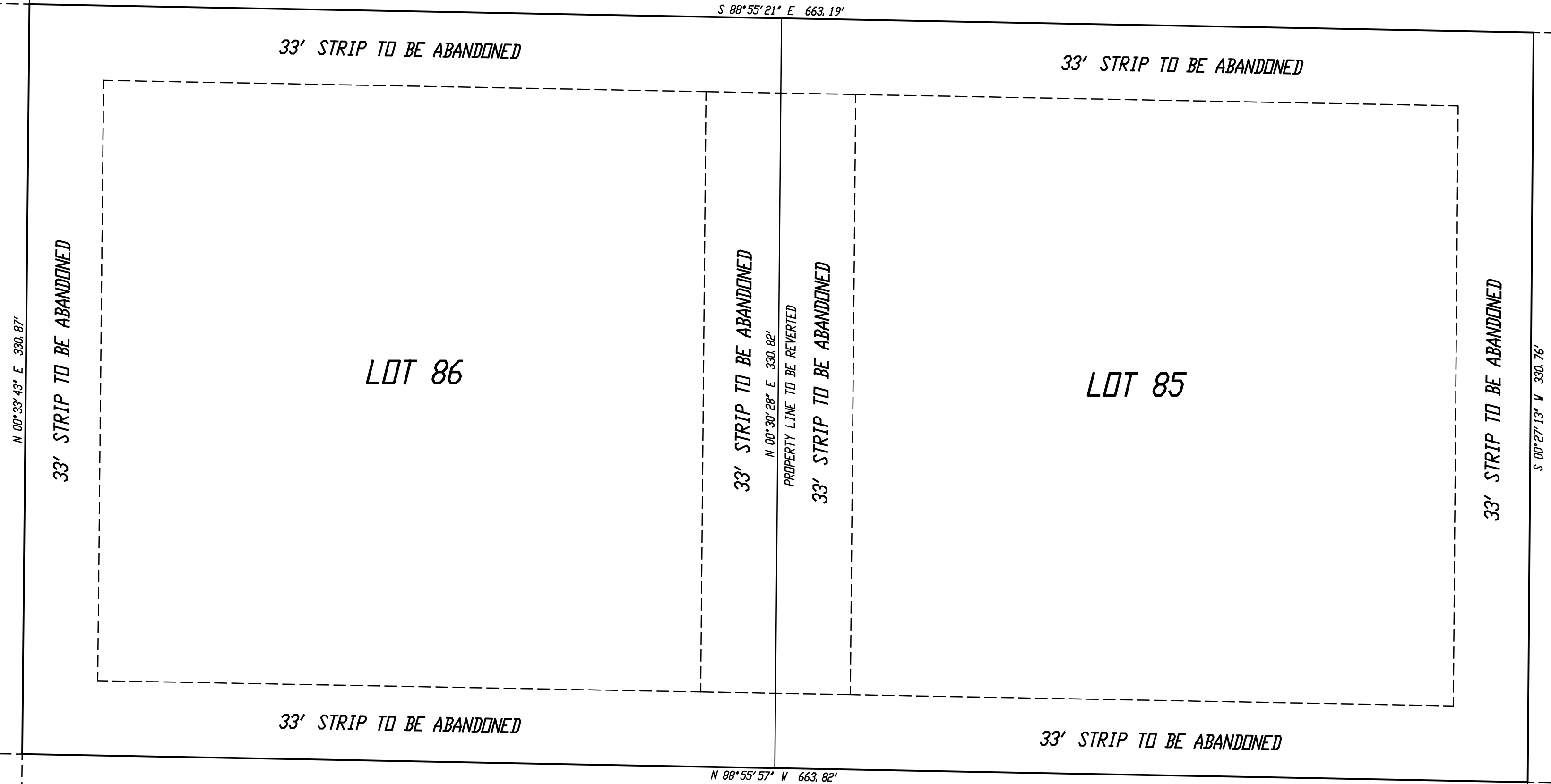

AREA OF ABANDONMENT = 1.80 AC.

BASIS OF BEARING
RECORD OF SURVEY NUMBER 5327.

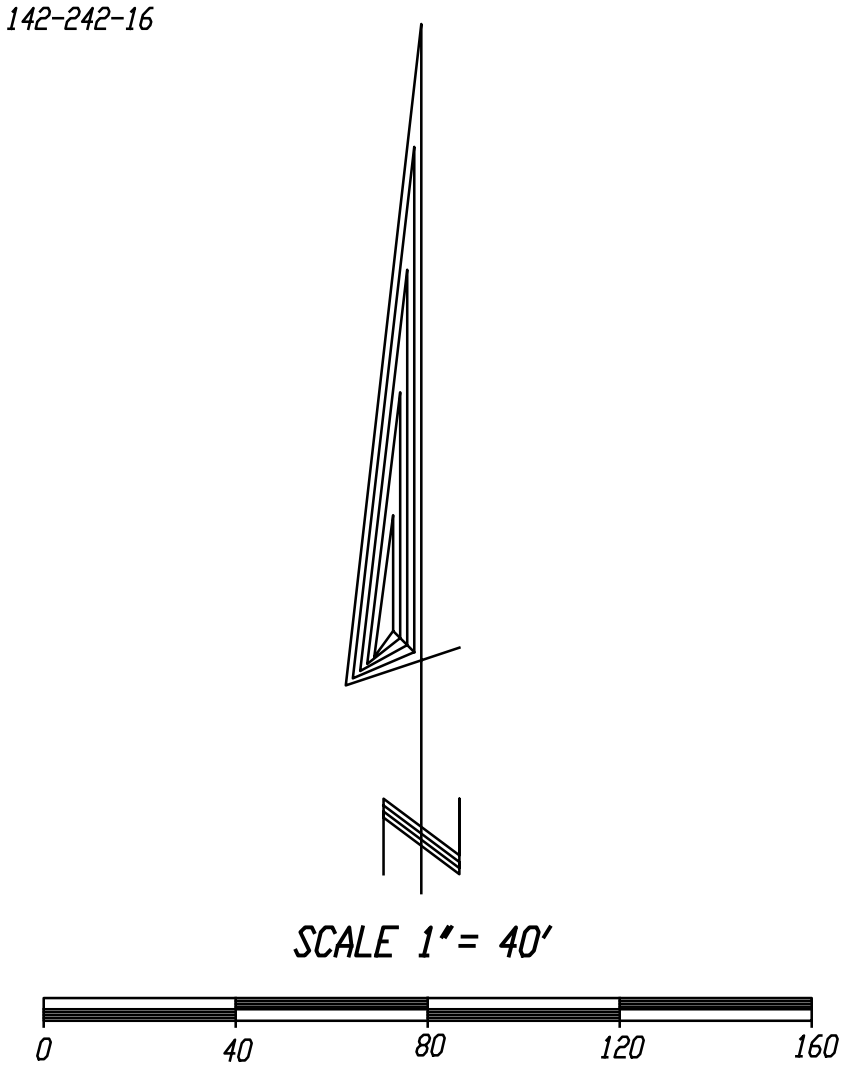

SITE PLAN
 FOR
KRISTIAN AND REGINA SIEVERT
 OF GOVERNMENT LOTS 85 & 86, DDC. # 347118
 APN 142-242-11
 JOB NUMBER 1510ABAN

PREPARED BY: LANDMARK SURVEYING
 2548 RAMPART TERRACE
 RENO, NEVADA 89519
 (775) 324-0904